

Determination of Sensorless Input Parameters of Solar Panel with Adaptive Neuro-Fuzzy Inference System (ANFIS) Method - syafar uddin.pdf

by Syafaruddin Syafaruddin

Submission date: 03-Nov-2018 10:56AM (UTC+0700)

Submission ID: 1032062088

File name: Determination of Sensorless Input Parameters of Solar Panel with Adaptive Neuro-Fuzzy Inference System (ANFIS) Method - syafar uddin.pdf

Word count: 5436

Character count: 29554

DETERMINATION OF SENSORLESS INPUT PARAMETERS OF SOLAR PANEL WITH ADAPTIVE NEURO-FUZZY INFERENCE SYSTEM (ANFIS) METHOD

SYAFARUDDIN^{1,*}, MUHAMMAD IQBAL ABUBAKAR¹, HIZKIA GLORIUS SOMA¹
SRI MAWAR SAID¹ AND SATRIANI LATIEF²

¹Department of Electrical Engineering
Universitas Hasanuddin

Jalan Poros Malino Km. 6, Gowa 92171, Indonesia

*Corresponding author: syafaruddin@unhas.ac.id

²Department of Architecture
Universitas Bosowa

Jalan Urip Sumoharjo Km. 4, Makassar 90231, Indonesia

Received February 2018; revised June 2018

ABSTRACT. *The paper aims to benefit the artificial neural network by means of the adaptive neuro-fuzzy inference system (ANFIS) method to determine the input parameters of solar panel without using any sensors. In this respect, the input parameters are the irradiance in W/m^2 and the cell temperature in degree Celsius. Normally, these two parameters are measured with pyranometer and temperature sensors which are expensive and giving the complexity of the solar panel systems. In this research, the parameters of irradiance and cell temperature are obtained with taking the voltage and current of one cell of solar panel as the input signals. These signals are given to ANFIS network through the training and validation process. As the ANFIS network is the multi input and single output network, there will be two developed ANFIS networks which indicate the estimated irradiance and cell temperature. The ANFIS networks are confirmed with the sum of square error regarding the type of membership function and the number of nodes structure.*

Keywords: ANFIS network, Irradiance, Cell temperature, Solar cell, Training and validation process

1. **Introduction.** The output power and energy performance of photovoltaic panel systems are high depending on the input parameters by means of the intensity of sunlight or irradiance in W/m^2 and cell temperature in degree Celsius. In fact, there has been non-linear dependency of input parameters of solar panel with the output performance. As results, the I - V characteristics of solar cell are non-linear to the variability of irradiance and cell temperature [1,2]. For conventional Silicon solar cell technologies under the constant temperature, the increase in irradiance level will increase in photocurrent or short-circuit current almost linearly but the open-circuit voltage increases logarithmically. However, under constant irradiance, the increased temperature is characterized by a slightly increasing short-circuit current and relatively strong decreasing open-circuit voltage. If the temperature is increased, the diffusion voltage within the p-n-junction of solar cell is reduced due to the existence of variable negative temperature-voltage coefficient, for instance, -2.1 mV/K in a Silicon solar cell [3]. In parallel, the short-circuit current increases with temperature by approximately $0.01\%/K$ due to the enhanced mobility of charge carriers within the semiconductor material composing solar cells [4].

DOI: 10.24507/ijicic.14.06.2259

In photovoltaic (PV) applications, it is very common and more interested to visualize the output power responses of solar panel in terms of irradiance and cell temperature variations. To some extents, the real-time simulation is designed to investigate the potential maximum output power under different scenarios of sun light intensity [5,6]. More accurate output power expectation due to variability of irradiance and cell temperature was presented utilizing with the intelligent techniques applications [7,8]. The visualization of real-time and continuous output power measurement with current and voltage sensors was utilized in the terminal output of solar panel and microcontroller processing unit [9].

Ideally, both input and output parameters are important to be known in order to determine the performance of the solar panel comprehensively. However, the researchers and the owners of solar panel installations are more interested in the output power and energy production. In fact, the inputs of irradiance and cell temperature are prominent to be identified as well in order to improve the overall PV system performance. However, provision sensors to measure the real-time irradiance and cell temperature make the additional complexity system increase and of course the cost of these auxiliary systems. In addition, the historical irradiance data cannot be obtained directly because of expensive solar irradiance meters. The cost of pyranometer to measure global incoming solar radiation is about more than \$1000 with capability of integrated transmitter [10], while the cost temperature sensor for solar cell with the capability of flat surface temperature sensor measurement is about more than \$300 [11].

It is common in solar panel applications, the solar irradiance which includes global, direct and diffuse irradiances is measured and analyzed with sensors technology. For instance, the placement of thermopile and photodiode based radiometric measurement for two years is utilized in the desert area [12,13]. The high quality assessment of surface solar irradiance is obtained from long-term satellite measurement [14]. The solar irradiance is also predicted using different methods, such as long short-term memory (LSTM) networks based local meteorological data training information for hourly day-ahead prediction of solar irradiance [15], the machine learning based daily global solar irradiance [16], the numerical weather forecasting and statistical learning based solar irradiance forecasting in the tropic area [17] and the Angstrom-PreScott (A-P) type models are widely used for novel solar irradiance forecasting [18]. It seems that the previous methods to measure the solar irradiance are too expensive due to sensor and satellite data utilization, the error forecasting may occur and the measurement requires field testing with wasting time consuming.

Similar to solar irradiance, the cell temperature of solar panel is measured with different approaches. Conventionally, the cell temperature is measured with thermal sensor located on the backside of photovoltaic panel surface. Also, the measurement of cell temperature is sometimes correlated with the solar irradiance in order to calculate the overall performance of photovoltaic systems [19]. Measuring the cell temperature is quite difficult and less accurate even though the EN 60904-5 measurement standard is applied due to limitation by the uncertainties of the various parameters, such as experimental uncertainty in the determination of the thermal voltage and other determined parameters that characterize module performance if the diode quality factor is not precisely known [20]. All these problems might be eliminated with using our proposed method [30].

The paper aims to benefit the artificial intelligent application by means of the adaptive neuro-fuzzy inference system (ANFIS) network to deal with the complexity of input-output data combination. The ANFIS network is also successfully applied for parameters prediction in multi-input parameters systems where the accuracy of prediction is determined by the modeling of fuzzy inference system with the learning ability of artificial neural network [21]. In the field of photovoltaic systems, the ANFIS network has been

used to solve different problems mainly in the area of modelling and tracking of maximum power [22,23]. Under variational meteorological data inputs, the ANFIS network has been used for modelling and simulation for estimated output power of photovoltaic systems where the high reliability and accuracy are confirmed better than conventional artificial neural network method [24]. The high accuracy and fast response of maximum power tracking performance is also shown with ANFIS network based control systems taking the input of irradiance and temperature [25]. Mostly in the previous studies, the parameters of irradiance and cell temperature are taken as the input parameters to estimate the performance output of photovoltaic systems; while in our study, these parameters are utilized as the output parameters considering the voltage and current of solar cell as the input parameters. Therefore, our proposed method offers another contribution regarding the implementation of ANFIS network to solve the non-linearity and non-predictable parameters in photovoltaic systems by designing the estimated parameters system without utilizing any sensors.

Another approach is proposed to determine the input irradiance and cell temperature of solar panel without using any sensor equipment by means the pyranometer and temperature sensor, respectively. In this case, a single cell of PV panel is utilized to measure discretely the voltage and current by the inputs of sunlight intensity and temperature using the mathematical equation of solar cell modeling. The data combination is used as the training data for adaptive neuro-fuzzy inference system (ANFIS) network taking the irradiance and cell temperature as the function of output voltage and current of solar cell. As the ANFIS is notified as the single output artificial neural network, there will be two consecutive networks with the first and second networks being the estimated irradiance and cell temperature, respectively with similar inputs of cell voltage and current. The performance of ANFIS network is then validated with the variable inputs of cell voltage and current according to the type of membership function and number nodes combination based on sum of square error as the performance index measurement.

The paper is organized in several sections. It starts with the explanation of importance to measure the input-output parameters of solar panel, although in reality researchers are more interested in measuring the output power and energy of solar panels. The explanation continues with the configuration of the proposed systems including the characteristic of solar cell modeling and development of ANFIS network. The paper more focuses on the benefit utilization of artificial intelligence method by means of the ANFIS network to measure the estimated irradiance and cell temperature without using any sensor equipment. The simulation results indicate that the ANFIS network is accurate enough to estimate the sunlight intensity on PV panel surface and cell temperature without installing pyranometer and temperature sensor as the auxiliary system for the overall PV system installation.

2. Configuration of the Proposed Systems. The proposed system in Figure 1 is generally divided into two connected systems, i.e., the modeling of solar cell and the design of adaptive neuro-fuzzy inference system (ANFIS) network. The solar panel consists of 36 cells connected in series with the inputs of irradiance (E) and cell temperature (T_c) to produce voltage and current at the terminal output. In this study, a single cell is selected and functioned as the input parameter sensors. In this respect, the characteristic of solar cell is determined to obtain the correlation between the input of irradiance and cell temperature and the outputs of voltage and current shown in the I - V curve of solar cell. The target of PV cell modeling is to find the data training for ANFIS network based on correlation data input-output of solar cell. Meanwhile, the ANFIS network is designed through the training and validation process in order to benefit the ANFIS network as

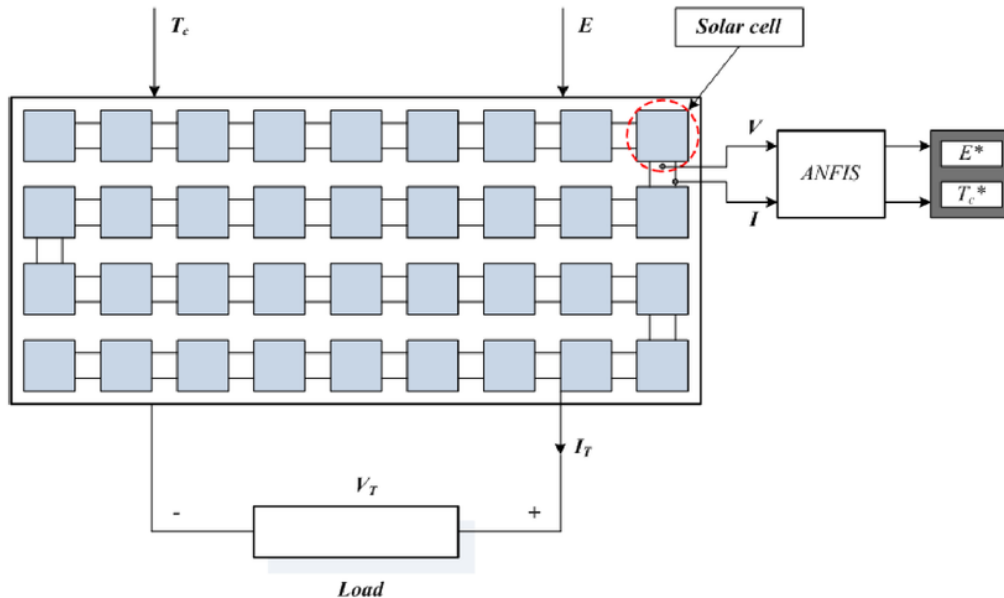

19
FIGURE 1. Configuration of the proposed system

the estimator for the irradiance (E^*) and cell temperature (T_c^*) parameters without using any sensor equipment. More detailed information of the proposed systems is presented as follows.

2.1. Characteristic modeling of solar cells. Electrical modeling of solar refers to determination of electrical parameters by means of the output voltage and current as the variation of intensity of sunlight and cell temperature. The process of analysis and synthesis of solar cell according to the characteristic of semiconductor composing the cell arrives at a suitable mathematical model that describes the relevant dynamic characteristics of the component and parameters in real practice [4]. The electric circuit of modeling of solar cell is presented in Figure 2.

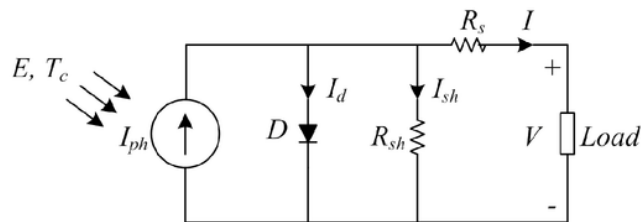

2
FIGURE 2. Electric circuit of modeling of solar cell

Under realistic conditions without irradiation, the solar cell is equal to an ordinary semiconductor diode whose effect is also maintained at the incidence of light. This is why diode D has been connected in parallel to the photovoltaic cell in the equivalent circuit diagram. Each p-n-junction also has a certain depletion layer capacitance, which is, however, typically neglected for modeling of solar cells. Series resistance R_s consists of the resistance of contacts and cables as well as of the resistance of the semiconductor

material itself. To minimize losses, cables should be provided with a maximum cross-section. Meanwhile, the parallel or shunt resistance R_{sh} includes the “leakage currents” at the photovoltaic cell edges at which the ideal shunt reaction of the p-n-junction may be reduced. However, for good mono-crystalline solar cells shunt resistance usually is within the $k\Omega$ region and thus has almost [35] effect on the current-voltage characteristic.

Based on the implementation of Kirchoff’s Law on the electric circuit in Figure 1, the mathematical equation in terms of cell current (I) and voltage (V) is derived as follows:

$$I = I_{ph} - I_d - I_{sh} \tag{1}$$

where I_{ph} , I_d and I_{sh} are the photocurrent, diode current and shunt current, respectively. These currents have dependency on other parameters which are described in the following equation.

$$I = I_{ph} - I_s \left[\exp \left(\frac{V + IR_s}{nk(T_c - T_{ref})} \right) - 1 \right] - \left(\frac{V + IR_s}{R_{sh}} \right) \tag{2}$$

The photocurrent (I_{ph}) is clearly varied according to the variation of irradiance level (E) in W/m^2 and cell temperature (T_c) in Kelvin as shown as follows:

$$I_{ph} = [I_{sc} + K_i(T_c - T_{ref})] \frac{E}{E_{ref}} \tag{3}$$

where I_{sc} is the short-circuit current in Ampere, K_i is the temperature coefficient of solar cell under short circuit condition, and E_{ref} and T_{ref} are the reference irradiance (W/m^2) and temperature (K), respectively.

Meanwhile, the diode current is depending on the diode saturation current (I_s) which is highly varied with temperature variation as shown in the following equation.

$$I_s = I_{RS} \left(\frac{T_c}{T_{ref}} \right)^3 \exp \left[\frac{qW_g}{nk} \left(\frac{1}{T_{ref}} - \frac{1}{T_c} \right) \right] \tag{4}$$

where I_{RS} is the reverse saturation current at the reference irradiance and temperature in Ampere, W_g is the band gap energy of solar cell which is 1.10 eV for Silicon solar cell and n is the diode ideality factor. The reverse saturation current itself can be calculated with the following equation:

$$I_{RS} = \frac{I_{sc}}{\exp \left(\frac{qV_{oc}}{nkT_c} \right) - 1} \tag{5}$$

where V_{oc} is the open-circuit voltage, k is the Boltzmann constant (1.38×10^{-23} J/K) and q is the electric charge (1.6×10^{-19} Coulomb).

The mathematical model of solar cell from Equations (1)-(5) is simulated in Matlab/Simulink program to obtain data correlation between the inputs of irradiance (E) and cell temperature (T_c) and the outputs of cell voltage (V) and current (I). In this study, similar data in [26] are assumed which are $I_{sc} = 1.9$ A, $E_{ref} = 1000$ W/m^2 , $T_{ref} = 300$ K, $K_i = 0.0017$, $R_s = 0.01$ Ω and $R_{sh} = 300$ Ω to be known. The I - V curves in Figures 3(a) and 3(b) are clearly indicated how the irradiance changes under constant temperature of $50^\circ C$ and the cell temperature changes under the constant irradiance of 800 W/m^2 , respectively. The variability data input-output will be used for the training process of ANFIS network in order to obtain the confirmed ANFIS structure for the estimated irradiance (E^*) and cell temperature (T_c^*) which will be explained in the next section.

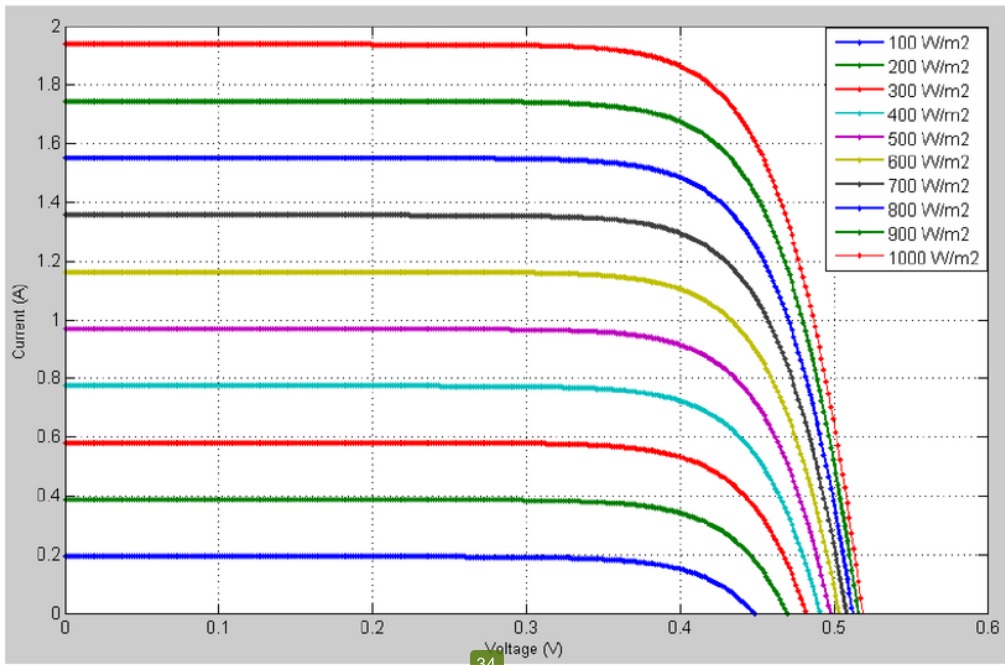

(a) Constant temperature of 50°C

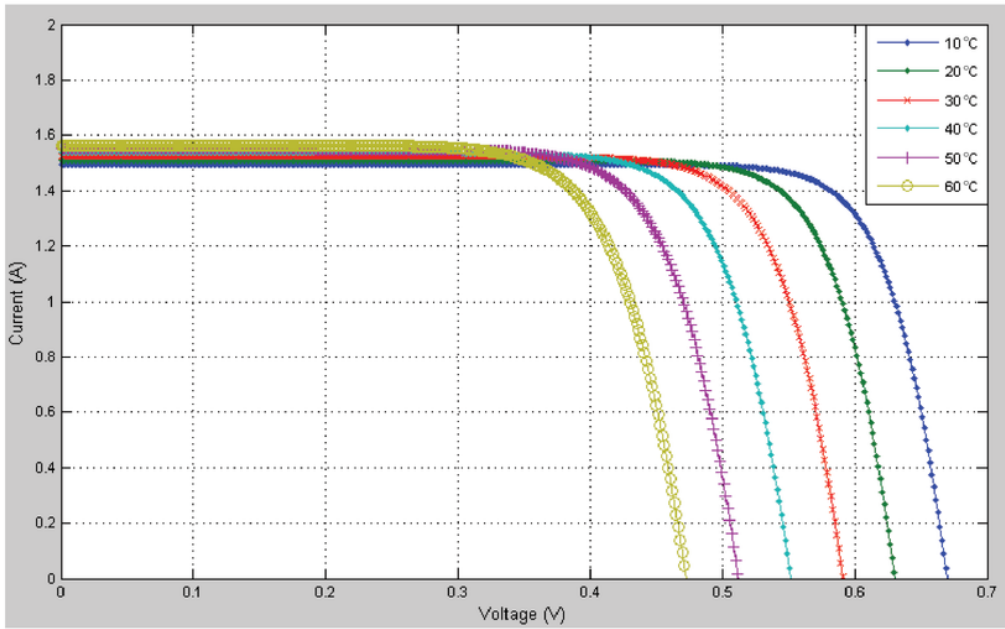

(b) Constant irradiance of 800 W/m²

FIGURE 3. *I-V* curve performance of solar cell

2.2. **Development of ANFIS network.** ANFIS network is especially designed for a single output, called, Sugeno type fuzzy inference systems (FIS). This method is considered as hybrid learning algorithm because it combines the least-squares and back propagation gradient descent methods for training FIS membership function parameters [27]. This approach can be applied for modeling the set input-output data. The training process using ANFIS method is very fast and the network structure is also directly confirmed. During the training process, once the number of epochs is reached, then the training is stopped.

For the first order Sugeno fuzzy model, the if-then rules are expressed as follows [28]:

Rule 1: If x_1 is A_1 and x_2 is B_1 , then $y_1 = p_1x_1 + q_1x_2 + r_1$

Rule 2: If x_1 is A_2 and x_2 is B_2 , then $y_2 = p_2x_1 + q_2x_2 + r_2$

where A_1, A_2, B_1 and B_2 are called the premise parameters and p, q, r are the coefficient parameters of the n th rule through the first order polynomial form expressed as:

$$y_n = p_nx_1 + q_nx_2 + r_n \tag{6}$$

where x_1, x_2 are the output voltage and current of solar cell, respectively and y is the output signal of ANFIS network by means of the estimated irradiance (E^*) and cell temperature (T_c^*) obtained through fuzzy rules processing.

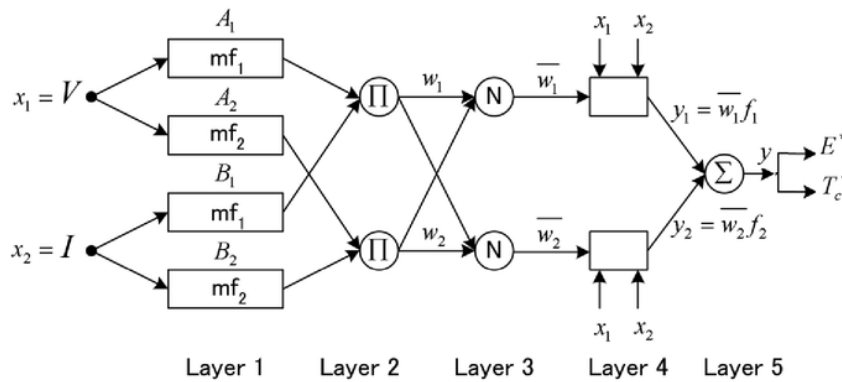

FIGURE 4. ANFIS structure for the first-order Sugeno type

The ANFIS structure is shown in Figure 4. This structure has five layers where each layer produces a certain output, denoted by O_i . The description of each layer is as follows.

Layer 1: This layer is to generate the grade of membership function of the input signals. Each node of this layer is adaptive node and its output can be expressed as:

$$O_1 = \mu_{Ai}(x) \tag{7}$$

where $\mu_{Ai}(x)$ is the membership function with linguistic label A for each node. This is the important part of ANFIS network by selecting the type and number of membership functions for each input signal. In this study, the best membership function and number of nodes for the membership function for each input signals $[V, I]$ are determined through the training process. The results of training process are expected enough to map between the estimated irradiance (E^*) and cell temperature (T_c^*) and the input signals. There is no guarantee that more accuracy of ANFIS network can be reached by increasing the number of membership functions for each input. In fact, the simulation progress and computational effort become very slow.

Layer 2: This layer is utilized to generate the firing strength. It indicates with π that means a simple multiplier. Each node of this layer produces the firing strength by multiplying rules generated in the first layer. The outcome of this layer is represented as:

$$O_2 = w_i = \prod_{j=1}^m \mu_{A_j}(x) \quad (8)$$

Layer 3: This layer is for normalization of the firing strength generated in the second layer, denoted by N . The i th node of the layer 3 calculates the ratio of the i th rule's firing strength to the total rule's firing strength. This duty is simply formulated as follows:

$$O_3 = \bar{w}_i = \frac{w_i}{w_1 + w_2} \quad (9)$$

Layer 4: This layer is to calculate the rule outputs based on the consequent parameters: p , q and r . The same as the layer 1, this layer contains adaptive node and adjusts the output parameters. The output of this layer simplifies the multiplication between the normalized firing strength and the first order polynomial, as shown below:

$$O_4 = y_i = \bar{w}_i(p_i x_1 + q_i x_2 + r_i) \quad (10)$$

for $i = 1, 2, 3, \dots$

Layer 5: This layer is to provide a single fixed node, denoted by sigma. The output of this node is the submission of all input signals from the previous layers. This output can be mathematically formulated by:

$$O_5 = \sum_i y_i = \bar{w}_1(p_1 x_1 + q_1 x_2 + r_1) + \bar{w}_2(p_2 x_1 + q_2 x_2 + r_2) \quad (11)$$

In this layer, the consequent parameters p , q and r are determined using the least square algorithm.

It seems that the ANFIS network architecture in this study is quite conventional and similar to the original Sugeno-type of fuzzy inference system (FIS). However, this ANFIS network is accurate enough to do mapping the non-linearity and non-predictable of input-output data combination between voltage-current and irradiance-cell temperature. It is another advantage of using hybrid paradigm of intelligent techniques that a simple ANFIS network without any structure modification is powerful to solve one of complex problems in photovoltaic system applications by means of the provision of data irradiance and cell temperature without deploying any pyranometer and temperature sensor surrounding the solar panel. Again, the diversity and proliferation method of ANFIS network is acknowledged as one of the powerful techniques being used and getting high attention in different fields of application.

3. Simulation Results and Discussions. The ANFIS network is actually the hybrid paradigm between the artificial neural network and fuzzy logic systems. If the systems get more complex and non-linear, the implementation of fuzzy logic system is more difficult and requires extra computational time to determine the appropriate fuzzy rules and proper membership function. In addition, although the fuzzy logic system has the reasoning capability, it has no ability to learn and to adapt. Meanwhile, the conventional artificial neural network needs extra computational efforts, less effective and more complicated when the structure data get more complex and the number of data patterns increases. Nevertheless, the artificial neural network has the ability to learn and adapt to the variation in input-output data. Therefore, the ANFIS network provides the benefits of both methods to end up with the one of powerful methods for the prediction, estimation and control of dynamic and complex systems in engineering problems.

The training process of ANFIS network is highly depending on the variability input-output obtained from the electrical characteristic modeling of solar cell in the previous section. The data range of irradiance (E) is 100-1000 W/m² with the increment of 100 W/m² and cell temperature (T_c) is 10-60°C with the increment of 10°C. For each input, the output current is measured within the voltage interval 0.1-0.6 V. With this approach, there are 3300 data combination of input-output of solar cell for data training that covers $(E, T_c) = f(V, I)$. In this study, the number of epoch set in the simulation is 40. In addition, the fuzzy inference system is trained with the optimal membership function parameters using the combination between the back-propagation and least square methods.

The target of training process is to determine the optimal membership function and number of nodes connection to the input signals based on the minimum training error. Since the ANFIS structure is denoted as a single output, two consecutive networks will be designed, i.e., the ANFIS network for estimated irradiance (E) and cell temperature (T_c^*). In this study, the types of fuzzy membership function that has been investigated are triangular membership function generator (*trimf*), trapezoidal membership function generator (*trapmf*), generalized Bell function fuzzy membership generator (*gbellmf*), Gaussian fuzzy membership function (*gaussmf*), Gaussian fuzzy membership function of two combined Gaussians (*gauss2mf*), Pi-function fuzzy membership generator (*pimf*), difference of two fuzzy sigmoid membership functions (*dsigmf*) and product of two sigmoid membership functions (*psigmf*). Meanwhile, the number of nodes connected to the input voltage and current is investigated from [3, 3], [4, 3], [4, 4], [5, 4], [5, 5], [6, 5], [6, 6], [7, 6] and [7, 7]. In this case for instance, the [3,3] is defined with 3-node connected to input voltage, another 3-nodes connected to the input current and so on.

After the error investigation during the training process of ANFIS network, the *gaussmf* is denoted as the best fuzzy membership function for estimated irradiance with the minimum error of 0.030522. Meanwhile, the *pimf* is found to be the optimal fuzzy membership function for estimated cell temperature with the minimum error of 0.0067447. The results indicate that the estimation of cell temperature will be more accurate than the estimation of irradiance. It might cause the combination of input-output data training process of $E = f(V, I)$ is more complex and highly non-linear than the data combination of $T_c = f(V, I)$. There is no possibility to improve the training error for estimated irradiance network, even though the number of nodes connected to the input signals is increased.

Unlikely the estimated cell temperature network, the minimum error during the training process can be decreased with the increase of input nodes connection. The nodes connection of [7, 6] yields the minimum error for estimated cell temperature. In this respect, the data correlation of $T_c = f(V, I)$ is more flexible than the $E = f(V, I)$. However, *trapmf* types of fuzzy membership function cannot give clear information regarding the error value of training process in estimated cell temperature network, especially for the number of nodes input of [5, 5] and [6, 5]. The error of training process in terms of the types of fuzzy membership function and the number of nodes connection to the inputs is shown in Table 1.

The confirmation of ANFIS network structure after the training process is shown in Figure 5, with Figure 5(a) for estimated irradiance and Figure 5(b) for estimated cell temperature. The input signals are solar cell output voltage and current connected to single output of estimated irradiance and cell temperature, respectively. For the estimated irradiance, there are 9 nodes of *inputmf*, 20 nodes of *outputmf* with 20 fuzzy rules generated. Meanwhile, there are 13 nodes of *inputmf*, 42 nodes of *outputmf* with 42 fuzzy rules obtained for the estimated cell temperature.

TABLE 1. Error in training process

MF types (E)	Combination of input nodes								
	[3,3]	[4,3]	[4,4]	[5,4]	[5,5]	[6,5]	[6,6]	[7,6]	[7,7]
trimf	0.033162	0.032946	0.032653	0.032064	0.031365	0.031786	0.031799	0.031346	0.031479
trapmf	0.033712	0.032928	0.032239	0.031328	0.032258	0.032602	0.032349	0.031189	0.030773
gbellmf	0.033242	0.031447	0.031683	0.031509	0.031242	0.031316	0.031738	0.030948	0.031252
gaussmf	0.033443	0.031408	0.031001	0.030522	0.031691	0.031054	0.031054	0.031039	0.030528
gauss2mf	0.031883	0.032789	0.033093	0.033474	0.03161	0.032727	0.031904	0.031977	0.031326
pimf	0.034656	0.032359	0.033782	0.031336	0.031399	0.032459	0.0316	0.0318352	0.030742
dsigmf	0.037855	0.032922	0.031796	0.031137	0.031449	0.031063	0.031535	0.031032	0.030971
psigmf	0.037855	0.032922	0.031796	0.031137	0.031449	0.031063	0.031535	0.031032	0.030971
MF types (T _c)	Combination of input nodes								
	[3,3]	[4,3]	[4,4]	[5,4]	[5,5]	[6,5]	[6,6]	[7,6]	[7,7]
trimf	0.023602	0.021407	0.021407	0.013054	0.015183	0.016012	0.011466	0.011466	0.011466
trapmf	0.027138	0.025001	0.025001	0.011144	not defined	not defined	0.0083926	0.0083926	0.0083926
gbellmf	0.020617	0.019465	0.019465	0.010299	0.0085162	0.010032	0.0097056	0.0097056	0.0097056
gaussmf	0.023823	0.024867	0.024867	0.014458	0.011041	0.010507	0.010625	0.010625	0.010625
gauss2mf	0.024947	0.028301	0.028301	0.013316	0.018635	0.0099329	0.011839	0.011839	0.011839
pimf	0.028065	0.025814	0.025814	0.010389	0.010264	0.010034	0.0069823	0.0067447	0.0069823
dsigmf	0.022858	0.02122	0.02122	0.010523	0.0081858	0.0082577	0.0091267	0.0091267	0.0091267
psigmf	0.022858	0.02122	0.02122	0.010523	0.0081858	0.0082005	0.0091255	0.0091255	0.0091255

The performance of ANFIS network as the estimator of irradiance and cell temperature is shown in Figure 6. From the 100% of data input-output combination, 70% of these data are used for testing of confirmed ANFIS network. The continuous input data signals of voltage and current are fed to the ANFIS network in order to obtain the estimated irradiance in W/m^2 and cell temperature in degree Celsius. This is one of the benefits of artificial neural network where the data for training process is discrete, while the data for validation is continuous. The performance of our proposed ANFIS network is highly accurate under random input signals, narrow variability input data indicated with $SSE_E = 1.135781669$ and $SSE_{T_c} = 1.148912529$ for estimated irradiance and cell temperature, respectively.

4. Conclusion. This paper has presented another approach of determining the input parameters by means of the irradiance and cell temperature in solar panel application without using any sensor equipment. The proposed method utilized the $I-V$ curve modeling of solar cell in order to obtain the data combination of irradiance and cell temperature as the functions of output cell voltage and current. These data were used for the training process of ANFIS network. The training results confirmed two network ANFIS structure for each estimated irradiance and cell temperature. For the estimated irradiance network structure, the optimal membership function is the *gaussmf* with 9 nodes connected to the input signals. Meanwhile, the optimal membership function is *pimf* with 13 nodes input connection for estimated cell temperature structure. In addition, the numbers of fuzzy rules are 20 and 42 for irradiance and cell temperature networks, respectively. The confirmed ANFIS network works as pyranometer to measure irradiance and temperature sensor to measure the cell temperature. The performance of ANFIS network has high accuracy even though the interval variations of voltage and current as the input signals are very narrow indicated with very small values of sum of square error (SSE). The SSE

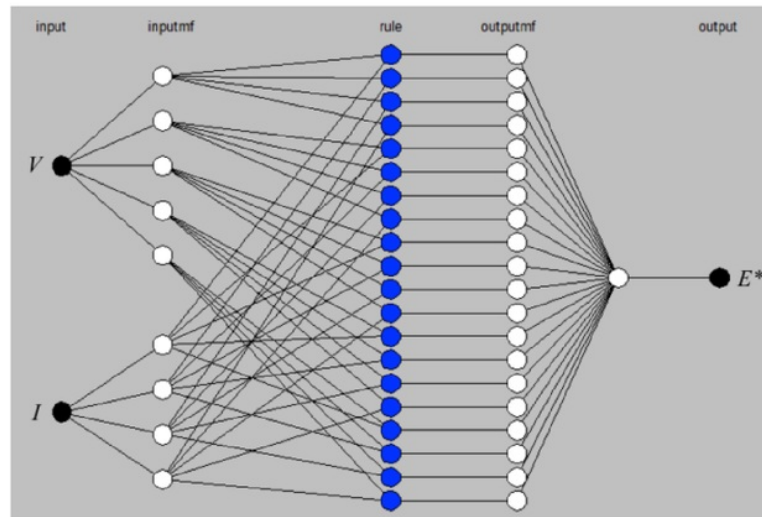

(a) Estimated irradiance

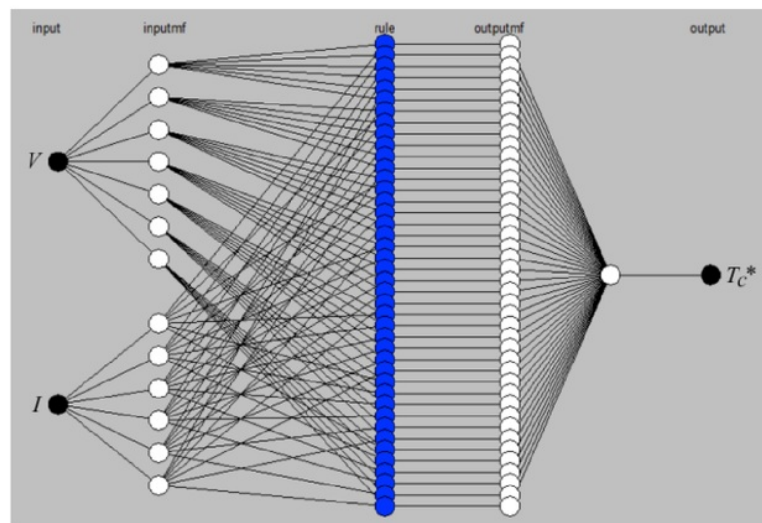

(b) Estimated cell temperature

FIGURE 5. Confirmation of ANFIS network

of estimated irradiance is 1.135781669, while the SSE of estimated cell temperature is 1.148912529.

The next stage of this study is to implement real-time testing for measuring the irradiance and cell temperature. Voltage and current sensors will be deployed for taking data from solar cell outputs. The analog signals of voltage and current will be connected through analog-digital (A/D) converter to the personal computer where the confirmed ANFIS network will process these data inputs. As results, the variations of irradiance and cell temperature can be monitored in the personal computer screen. The mechanism of this study will be performed under dSPACE based real-time Matlab/Simulink environment.

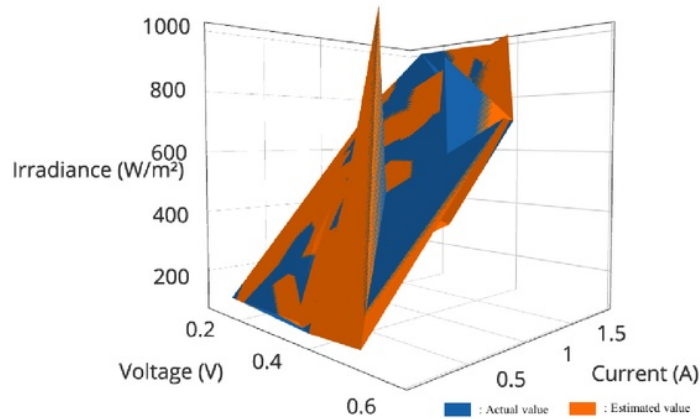

(a) Irradiance

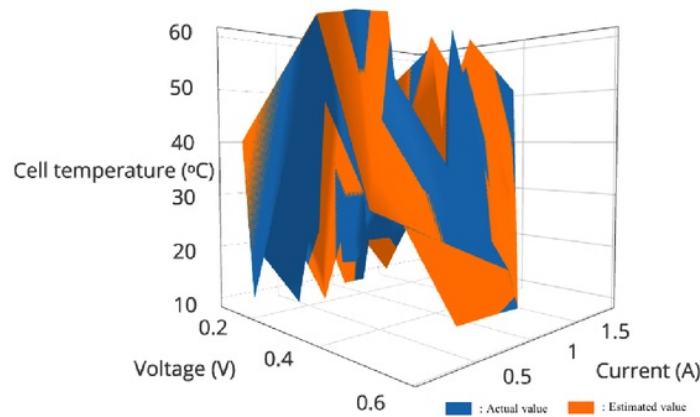

(b) Cell temperature

FIGURE 6. Verification results

4

Acknowledgement. This research is granted by the National Ministry of Research, Technology and Higher Education of Indonesia under the scheme of *Penelitian Dasar Unggulan Perguruan Tinggi* (PDUPT) year of 2017.

REFERENCES

- [1] M. Kaltschmitt, W. Streicher and A. Wiese, *Renewable Energy: Technology, Economics and Environments*, Springer, 2007.
- [2] L. Freris, *David Infield, Renewable Energy in Power Systems*, Wiley, 2008.
- [3] S. Chander, A. Purohit, A. Sharma, Arvind, S. P. Nehra and M. S. Dhaka, A study on photovoltaic parameters of mono-crystalline silicon solar cell with cell temperature, *Energy Reports*, vol.1, pp.104-109, 2015.
- [4] Syafaruddin, F. A. Samman, Alfian, M. A. Idris, S. H. Ahsan and S. Latief, Characteristics approach of thin-film CIGS PV cells with conventional mono-crystalline silicon model, *International Journal of Innovative Computing, Information and Control*, vol.12, no.1, pp.171-180, 2016.
- [5] Syafaruddin, E. Karatepe and T. Hiyama, Artificial neural network-polar coordinated fuzzy controller based maximum power point tracking control under partially shaded conditions, *IET Renewable Power Generation*, vol.3, no.2, pp.239-253, 2009.

- [6] Syafaruddin, E. Karatepe and T. Hiyama, Polar coordinated fuzzy controller based real-time maximum power point control of photovoltaic system, *Renewable Energy*, vol.34, no.12, pp.2597-2606, 2009.
- [7] Syafaruddin, E. Karatepe and T. Hiyama, ANN based real-time estimation of power generation of different PV module types, *IEEJ Trans. Power and Energy*, vol.129, no.6, pp.783-790, 2009.
- [8] Syafaruddin, E. Karatepe and T. Hiyama, Development of real-time simulator based on intelligent techniques for maximum power point controller of photovoltaic system, *International Journal of Innovative Computing, Information and Control*, vol.6, no.4, pp.1623-1642, 2010.
- [9] Syafaruddin, N. C. Mendeng, P. Master and Z. Muslimin, Real-time and continuous output power monitoring of photovoltaic (PV) systems, *ICIC Express Letters*, vol.9, no.1, pp.9-16, 2015.
- [10] <http://www.omniinstruments.co.uk/weather-stations-and-instruments/pyranometers-solar-irradiance.html>, 2018.
- [11] <http://www.globalw.com/products/we710.html#Options>, 2018.
- [12] M. Al-Rasheedi, C. A. Gueymard, A. Ismail and T. Hussain, Comparison of two sensor technologies for solar irradiance measurement in a desert environment, *Solar Energy*, vol.161, pp.194-206, 2018.
- [13] J. Kuusk and A. Kuusk, Hyperspectral radiometer for automated measurement of global and diffuse sky irradiance, *Journal of Quantitative Spectroscopy and Radiative Transfer*, vol.204, pp.272-280, 2018.
- [14] M. Dirksen, J. F. Meirink and R. Sluiter, Quality assessment of high-resolution climate records of satellite derived solar irradiance, *Energy Procedia*, vol.125, pp.221-229, 2017.
- [15] X. Qing and Y. Niu, Hourly day-ahead solar irradiance prediction using weather forecasts by LSTM, *Energy*, vol.148, pp.461-468, 2018.
- [16] A. Sharma and A. Kakkar, Forecasting daily global solar irradiance generation using machine learning, *Renewable and Sustainable Energy Reviews*, vol.82, no.3, pp.2254-2269, 2018.
- [17] H. Verbois, R. Huva, A. Rusydi and W. Walsh, Solar irradiance forecasting in the tropics using numerical weather prediction and statistical learning, *Solar Energy*, vol.162, pp.265-277, 2018.
- [18] E. Akarslan, F. O. Hocaoglu and R. Edizkan, Novel short term solar irradiance forecasting models, *Renewable Energy*, vol.123, pp.58-66, 2018.
- [19] C. Coskun, U. Toygar, O. Sarpdag and Z. Oktay, Sensitivity analysis of implicit correlations for photovoltaic module temperature: A review, *Journal of Cleaner Production*, vol.164, pp.1474-1485, 2017.
- [20] F. Mavromatakis, E. Kavoussanaki, F. Vignola and Y. Franghiadakis, Measuring and estimating the temperature of photovoltaic modules, *Solar Energy*, vol.110, pp.656-666, 2014.
- [21] U. Çaydaş, A. Haşçalık and S. Ekici, An adaptive neuro-fuzzy inference system (ANFIS) model for wire-EDM, *Expert Systems with Applications*, vol.36, no.3, pp.6135-6139, 2009.
- [22] F. Belhachat and C. Larbes, Global maximum power point tracking based on ANFIS approach for PV array configurations under partial shading conditions, *Renewable and Sustainable Energy Reviews*, vol.77, pp.875-889, 2017.
- [23] A. A. Aldair, A. A. Obed and A. F. Halihal, Design and implementation of ANFIS-reference model controller based MPPT using FPGA for photovoltaic system, *Renewable and Sustainable Energy Reviews*, vol.82, pp.2202-2217, 2018.
- [24] A. Mellit and S. A. Kalogirou, ANFIS-based modelling for photovoltaic power supply system: A case study, *Renewable Energy*, vol.36, no.1, pp.250-258, 2011.
- [25] R. K. Kharb, S. L. Shimi, S. Chatterji and M. F. Ansari, Modeling of solar PV module and maximum power point tracking using ANFIS, *Renewable and Sustainable Energy Reviews*, vol.33, pp.602-612, 2014.
- [26] W. A. El-Basit, A. M. A. El-Maksood and F. A. E.-M. S. Soliman, Mathematical model for photovoltaic cells, *Leonardo Journal of Sciences*, vol.12, no.23, pp.13-28, 2013.
- [27] Syafaruddin, E. Karatepe and T. Hiyama, Comparison of ANN models for estimating optimal points of crystalline silicon photovoltaic modules, *IEEJ Trans. Power and Energy*, vol.130, no.7, pp.661-669, 2010.
- [28] A. A. Elbaset and T. Hiyama, Fault detection and classification in transmission lines using ANFIS, *IEEJ Trans. Industry Applications*, vol.129, no.7, pp.705-713, 2009.

Determination of Sensorless Input Parameters of Solar Panel with Adaptive Neuro-Fuzzy Inference System (ANFIS) Method - syafar uddin.pdf

ORIGINALITY REPORT

26%

SIMILARITY INDEX

15%

INTERNET SOURCES

24%

PUBLICATIONS

7%

STUDENT PAPERS

PRIMARY SOURCES

- 1 Syafaruddin, Engin Karatepe, Takashi Hiyama. "Comparison of ANN Models for Estimating Optimal Points of Crystalline Silicon Photovoltaic Modules", IEEJ Transactions on Power and Energy, 2010
Publication 8%
 - 2 www.cs.kumamoto-u.ac.jp
Internet Source 3%
 - 3 Martin Kaltschmitt. "Photovoltaic Power Generation", Renewable Energy, 2007
Publication 2%
 - 4 repository.unhas.ac.id
Internet Source 2%
 - 5 Syafaruddin, Engin Karatepe, Takashi Hiyama. "Polar coordinated fuzzy controller based real-time maximum-power point control of photovoltaic system", Renewable Energy, 2009
Publication 1%
-

6	journals.pan.pl Internet Source	1%
7	Syafaruddin, Engin Karatepe, Takashi Hiyama. "Fuzzy wavelet network identification of optimum operating point of non-crystalline silicon solar cells", <i>Computers & Mathematics with Applications</i> , 2012 Publication	1%
8	TOYLAN, Hayrettin and HÜNER, Engin. "Uyarlamalı Sinirsel Bulanık Çıkarım (ANFIS) Tabanlı Güneş Takip Sistemi", Afyon Kocatepe Üniversitesi, 2017. Publication	1%
9	solardat.uoregon.edu Internet Source	1%
10	ljs.academicdirect.org Internet Source	1%
11	Gamil, M.M., N.A. Elsonbaty, and M.A. Enany. "Modelling of a directly coupled PV water pumping system using soft computing techniques", <i>Michael Faraday IET International Summit 2015</i> , 2015. Publication	1%
12	Xiangyun Qing, Yugang Niu. "Hourly day-ahead solar irradiance prediction using weather forecasts by LSTM", <i>Energy</i> , 2018	1%

13

crses.sun.ac.za

Internet Source

<1%

14

www.ijicic.org

Internet Source

<1%

15

Wahiba Yaïci, Evgueniy Entchev. "Adaptive Neuro-Fuzzy Inference System modelling for performance prediction of solar thermal energy system", Renewable Energy, 2016

Publication

<1%

16

Yan, H.. "Adaptive neuro fuzzy inference system for classification of water quality status", Journal of Environmental Sciences, 201012

Publication

<1%

17

MacKunis, W., M. Reyhanoglu, and S. Drakunov. "Robust and adaptive maximum power point tracking for standalone photovoltaic systems using a sliding mode control approach", 2012 7th IEEE Conference on Industrial Electronics and Applications (ICIEA), 2012.

Publication

<1%

18

Submitted to Savitribai Phule Pune University

Student Paper

<1%

19

Syafaruddin, , E. Karatepe, and T. Hiyama.

"Artificial neural network-polar coordinated fuzzy controller based maximum power point tracking control under partially shaded conditions", IET Renewable Power Generation, 2009.

Publication

<1%

20

www.isap-power.org

Internet Source

<1%

21

Emre Akarslan, Fatih Onur Hocaoglu, Rifat Edizkan. "Novel short term solar irradiance forecasting models", Renewable Energy, 2018

Publication

<1%

22

Kuo, Yeong-Chau, Yung-Jie Luo, and Li-Jen Liu. "Synthesizable Integrated Circuit and System Design for Solar Chargers", IEEE Transactions on Power Electronics, 2012.

Publication

<1%

23

Roosbeh Izadi-Zamanabadi, Mogens Blanke, Seraj Katebi. "Structural Modeling and Fuzzy-Logic Based Diagnosis of a Ship Propulsion Benchmark", IFAC Proceedings Volumes, 2000

Publication

<1%

24

A. Hadj Arab, F. Chenlo, M. Benganem. "Loss-of-load probability of photovoltaic water pumping systems", Solar Energy, 2004

Publication

<1%

Enany, Mohamed A., Mohamed A. Farahat, and Ahmed Nasr. "Modeling and evaluation of main maximum power point tracking algorithms for photovoltaics systems", Renewable and Sustainable Energy Reviews, 2016.

Publication

Arash Anzalchi, Arif Sarwat. "Artificial neural network based Duty Cycle estimation for maximum Power Point tracking in Photovoltaic systems", SoutheastCon 2015, 2015

Publication

Mouna Ben Hamed, Lassaad Sbita, Aymen Flah, Aicha Abid, Radia Guarraoui. "A real time implementation of an improved MPPT controller for photovoltaic systems", 2012 First International Conference on Renewable Energies and Vehicular Technology, 2012

Publication

E. M. Natsheh, A. Albarbar, J. Yazdani. "Modeling and control for smart grid integration of solar/wind energy conversion system", 2011 2nd IEEE PES International Conference and Exhibition on Innovative Smart Grid Technologies, 2011

Publication

30

www.inass.org

Internet Source

<1%

31

Mohamed Lasheen, Mazen Abdel-Salam. "Maximum power point tracking using Hill Climbing and ANFIS techniques for PV applications: A review and a novel hybrid approach", Energy Conversion and Management, 2018

Publication

<1%

32

Fatih Onur Hocaoglu, Fatih Serttas. "A novel hybrid (Mycielski-Markov) model for hourly solar radiation forecasting", Renewable Energy, 2017

Publication

<1%

33

Lecture Notes in Computer Science, 2015.

Publication

<1%

34

Lun, Shu-xian Sang, Jing-shu Guo, Ting-t. "A new six-parameter model based on Chebyshev polynomials for solar cells.(Research Article) (Report)", Mathematical Problems in Engineering, Annual 2015 Issue

Publication

<1%

35

file.scirp.org

Internet Source

<1%

36

Padmini, D.. "Ultimate bearing capacity prediction of shallow foundations on

<1%

cohesionless soils using neurofuzzy models",
Computers and Geotechnics, 200801

Publication

37

Akarслан, Emre, and Fatih Onur Hocaoglu. "A novel adaptive approach for hourly solar radiation forecasting", Renewable Energy, 2016.

Publication

<1%

38

www.ijmer.com

Internet Source

<1%

39

Syafaruddin, , E. Karatepe, and T. Hiyama. "Controlling of artificial neural network for fault diagnosis of photovoltaic array", 2011 16th International Conference on Intelligent System Applications to Power Systems, 2011.

Publication

<1%

40

Li, Yanlei Hu, Youmin Wu, Bo Fan, Jikai. "Thermal error modelling of the spindle using data transformation and adaptive neurofuzzy inference s", Mathematical Problems in Engineering, Annual 2015 Issue

Publication

<1%

Exclude quotes On

Exclude matches < 5 words

Exclude bibliography On